

Data Sheet



Article number: 021500700070

Description: Sealing Clamp S 70 W5

Measures

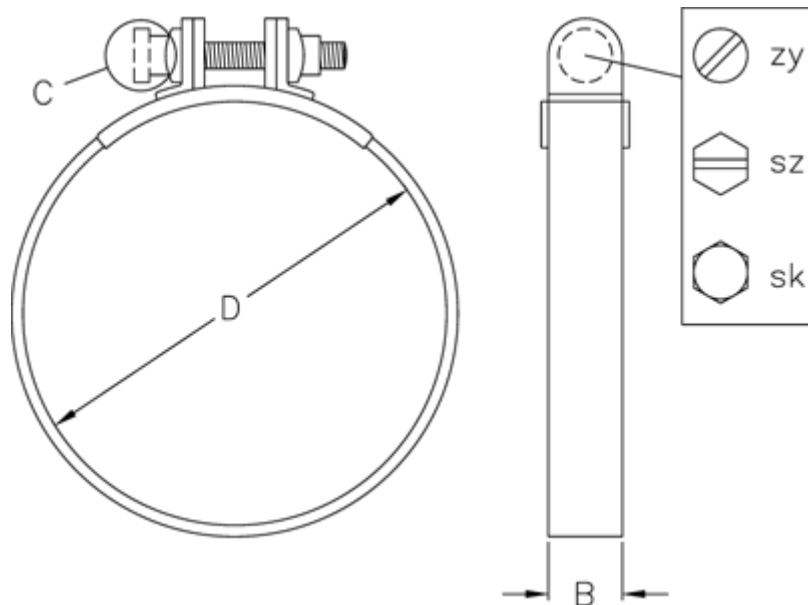

C (screw type) = SZ

Diameter D = 70

Width B = 20